



DRAWINGS ARE FOR TENDER PURPOSES ONLY

Rev	dd/mm/yyyy	Description	Rev by	dd/mm/yyyy

Designed : IPEG
 Checked : 
 Approved : 

Client
**SHILLONG
 SMART CITY LIMITED**

Submitted By
IPE GLOBAL
 Expanding Horizons. Enriching Lives.

Project:
DEVELOPMENT OF SMART ROAD IN SHILLONG

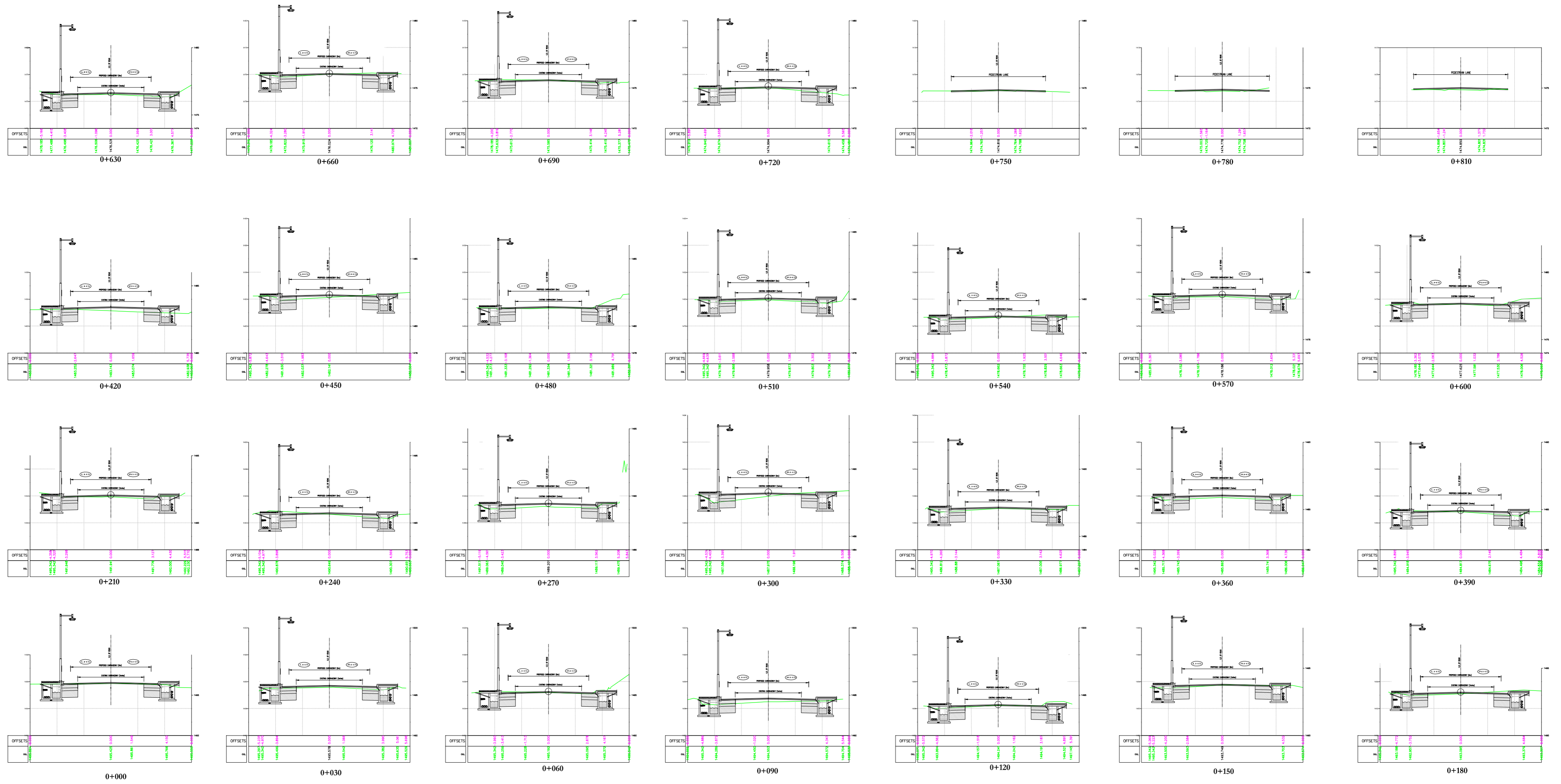

Drg Title:
**(RD-07)
 CROSS SECTIONS
 (From STA : 0+000 to STA : 0+254.645)**

Drg No : RD-7/CS-07/1
 Scale : NTS
 Date : 10.02.2020
 Contract No. :
 Rev R0



DRAWINGS ARE FOR TENDER PURPOSES ONLY

Rev	dd/mm/yyyy	Description	Rev by	dd/mm/yyyy

Designed : IPEG
 Checked : 
 Approved : 

Client
SHILLONG SMART CITY LIMITED

Submitted By

 Expanding Horizons. Enriching Lives.

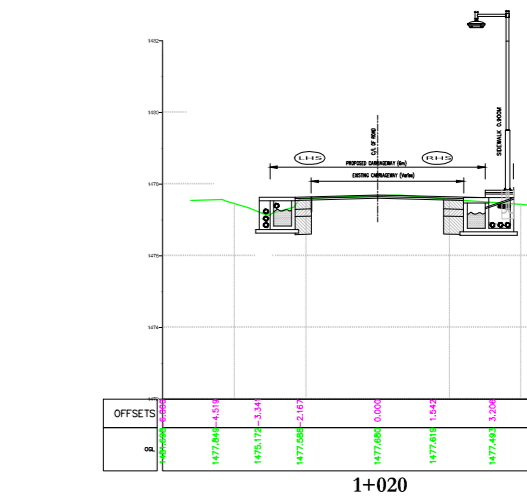
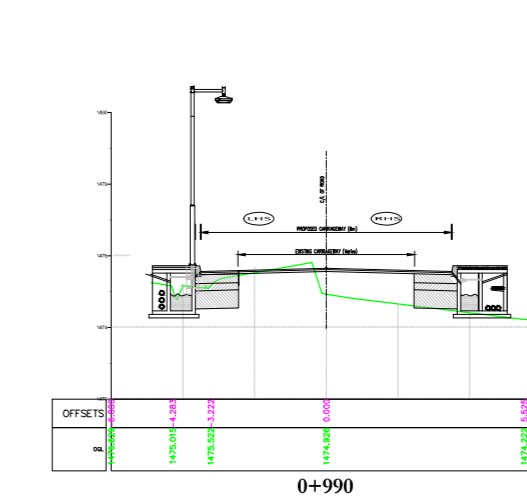
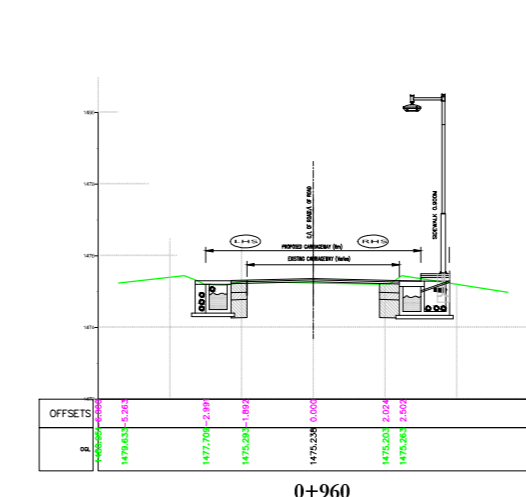
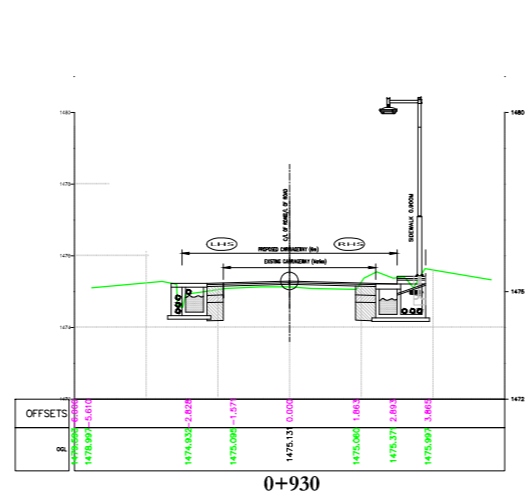
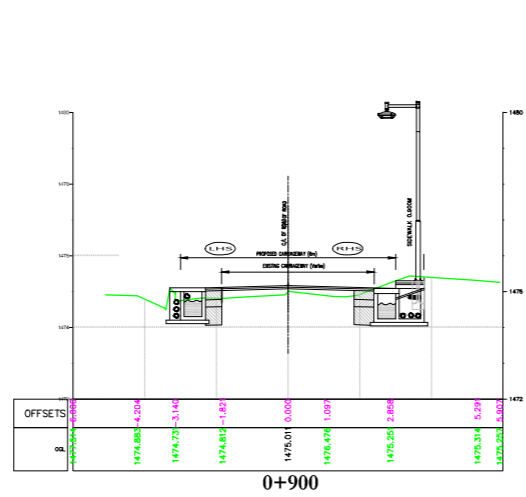
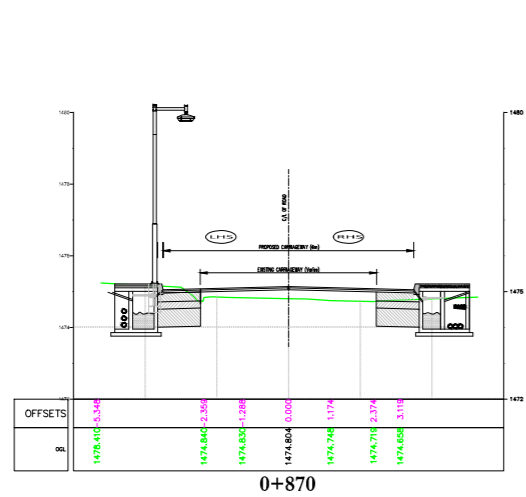
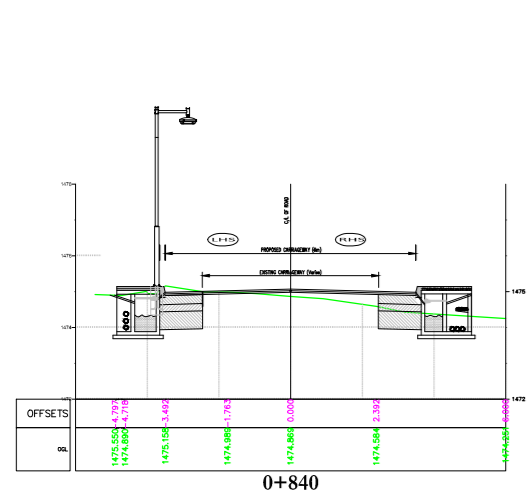
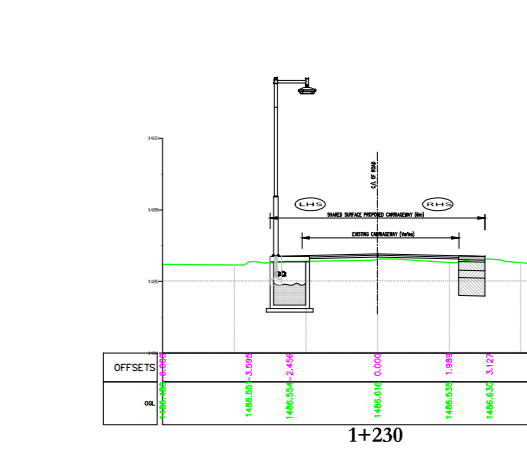
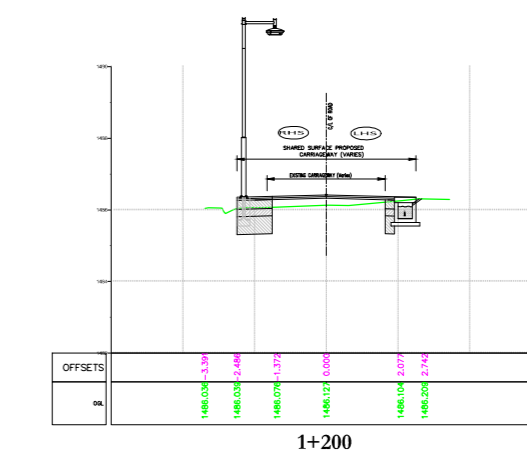
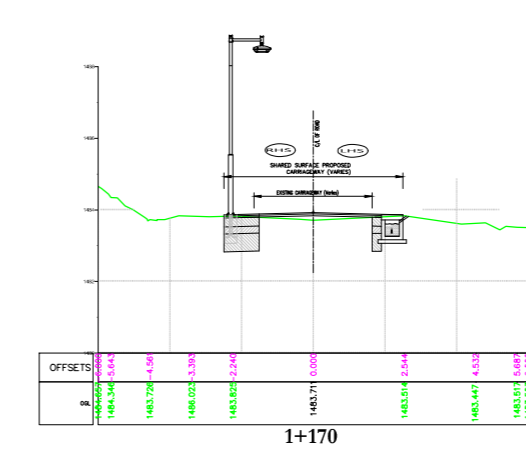
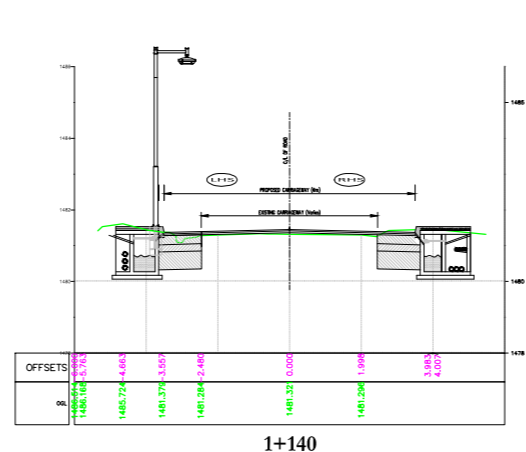
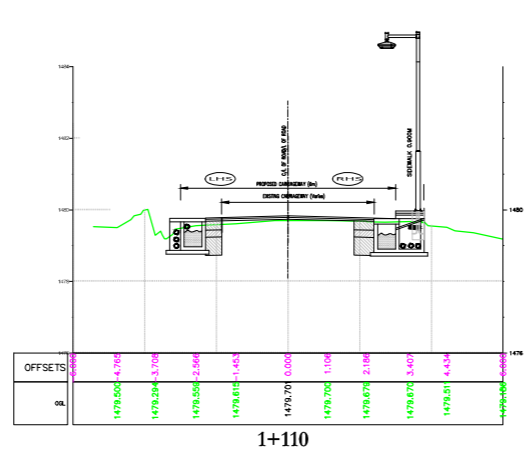
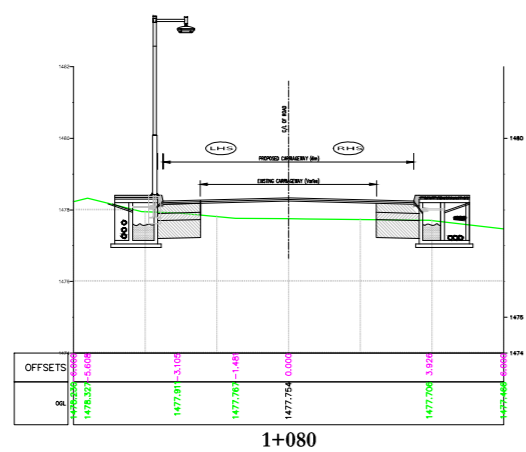
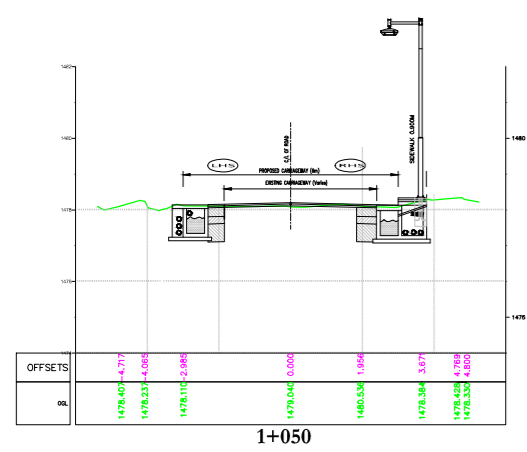
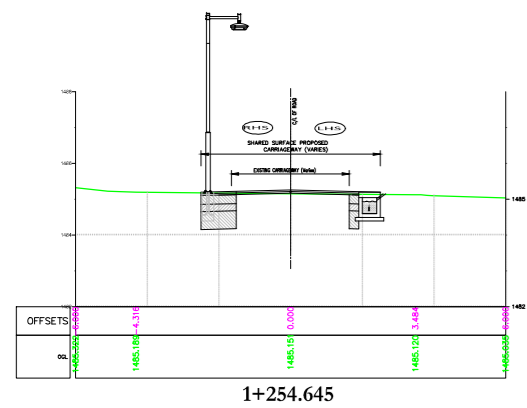

Project:
DEVELOPMENT OF SMART ROAD IN SHILLONG
 Drg Title:
**(RD-07)
 CROSS SECTIONS
 (From STA : 0+000 to STA : 0+254.645)**

Drg No : RD-7/CS-07/1
 Scale : NTS
 Date : 10.02.2020
 Contract No. :
 Rev R0



DRAWINGS ARE FOR TENDER PURPOSES ONLY

Rev	dd/mm/yyyy	Description	Rev by	dd/mm/yyyy

Designed : IPEG
 Checked : 
 Approved : 

Client
SHILLONG SMART CITY LIMITED

Submitted By

 Expanding Horizons. Enriching Lives.

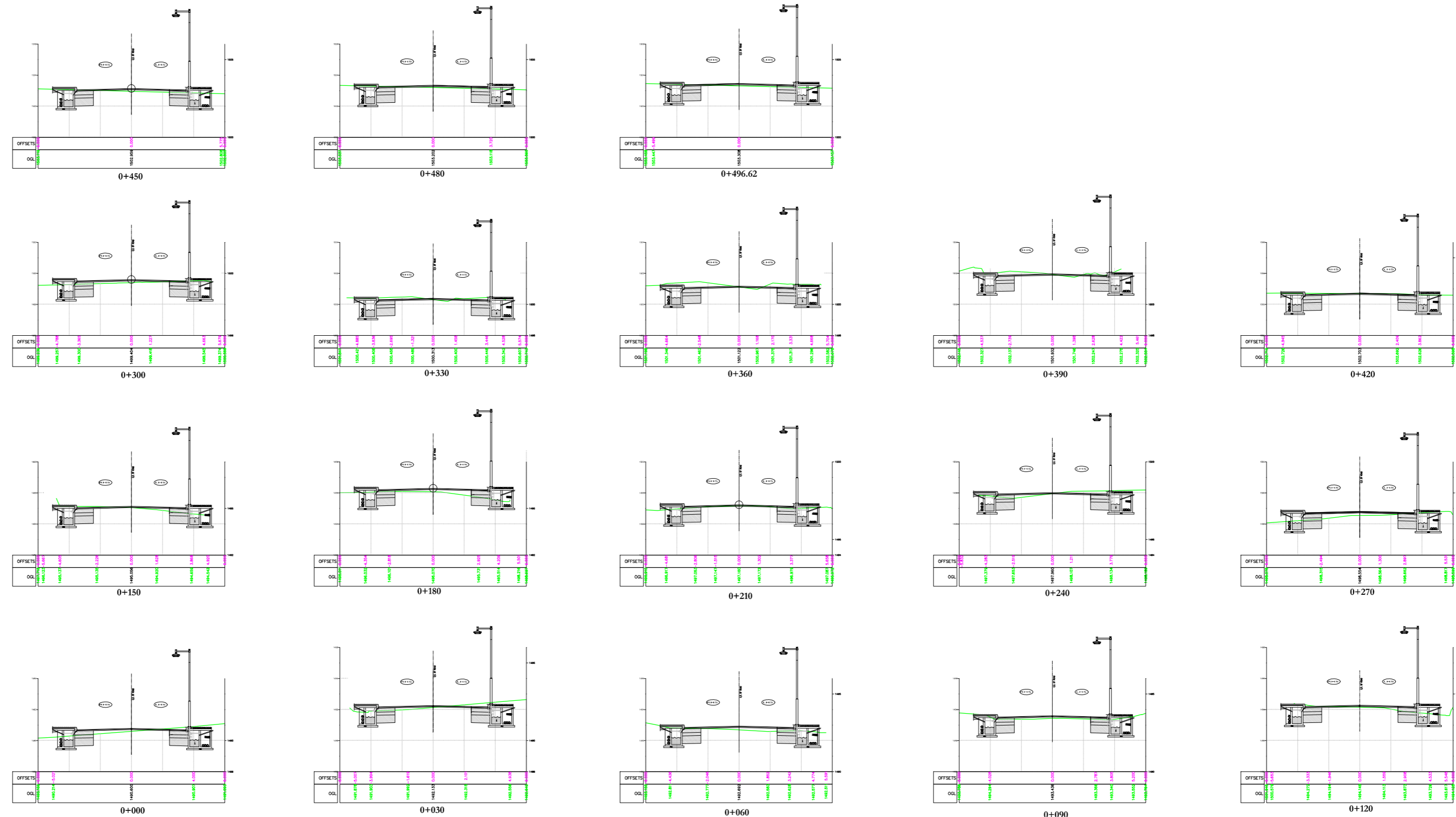

Project:
DEVELOPMENT OF SMART ROAD IN SHILLONG
 Drg Title:
**(RD-07)
 CROSS SECTIONS
 (From STA : 0+000 to STA : 0+254.645)**

Drg No : RD-7/CS-07/2
 Scale : NTS
 Date : 10.02.2020
 Contract No. :
 Rev R0



DRAWINGS ARE FOR TENDER PURPOSES ONLY

Rev	dd/mm/yyyy	Description	Rev by	dd/mm/yyyy

Designed : IPEG
 Checked : 
 Approved : 

Client
SHILLONG SMART CITY LIMITED

Submitted By

 Expanding Horizons. Enriching Lives.

Project:
DEVELOPMENT OF SMART ROAD IN SHILLONG
 Drg Title:
**(RD-08)
 CROSS SECTIONS
 (From STA : 0+000 to STA : 0+496.62)**

Drg No : RD-8/CS-08
 Scale : NTS
 Date : 10.02.2020
 Contract No. :
 Rev : R0

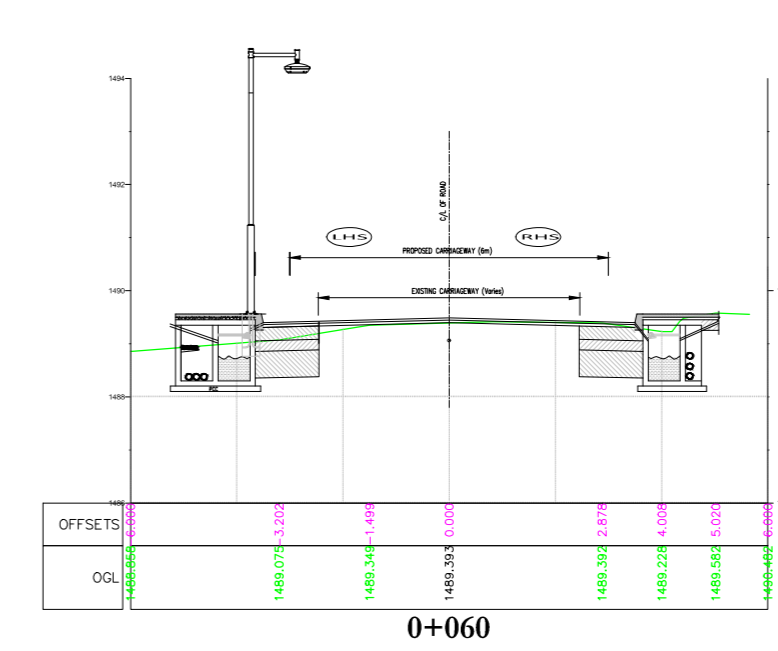
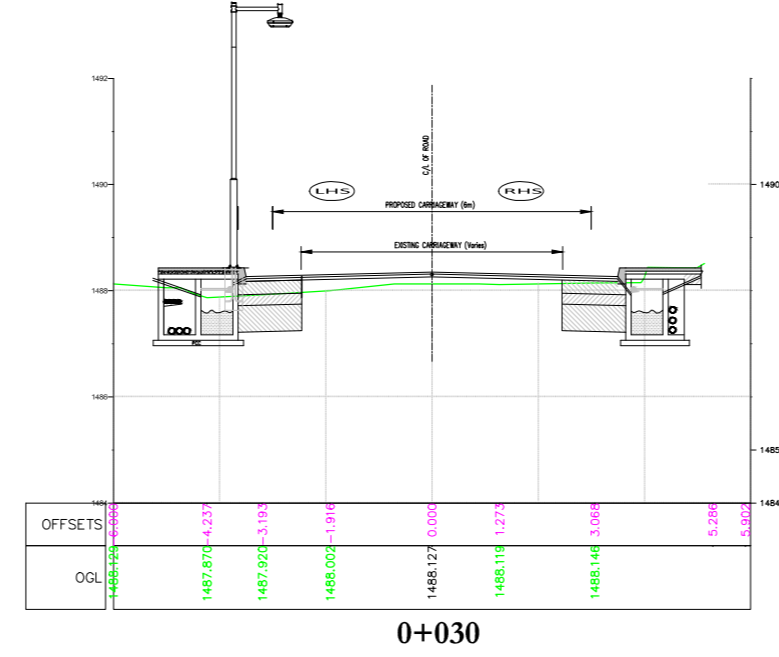
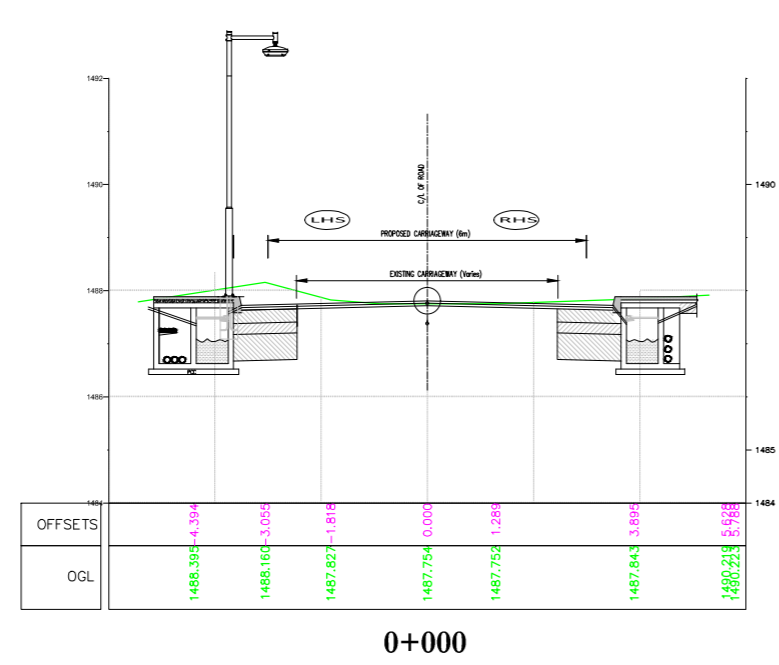
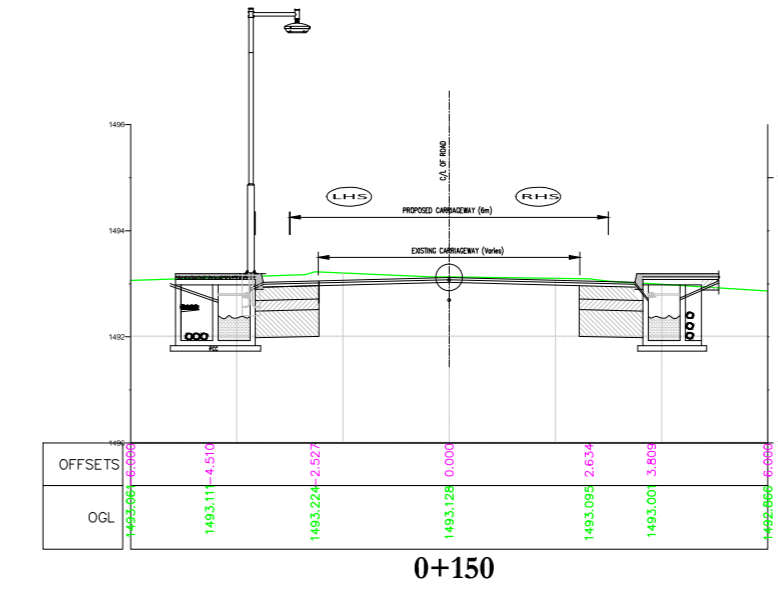
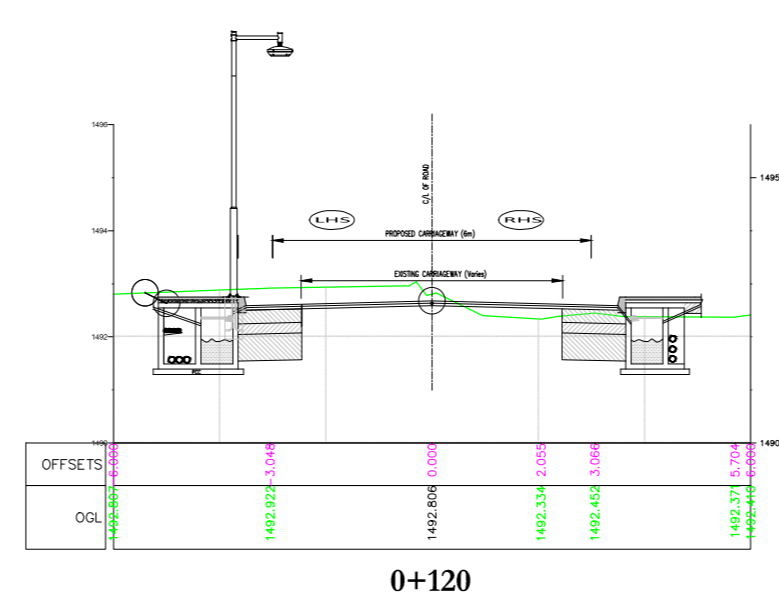
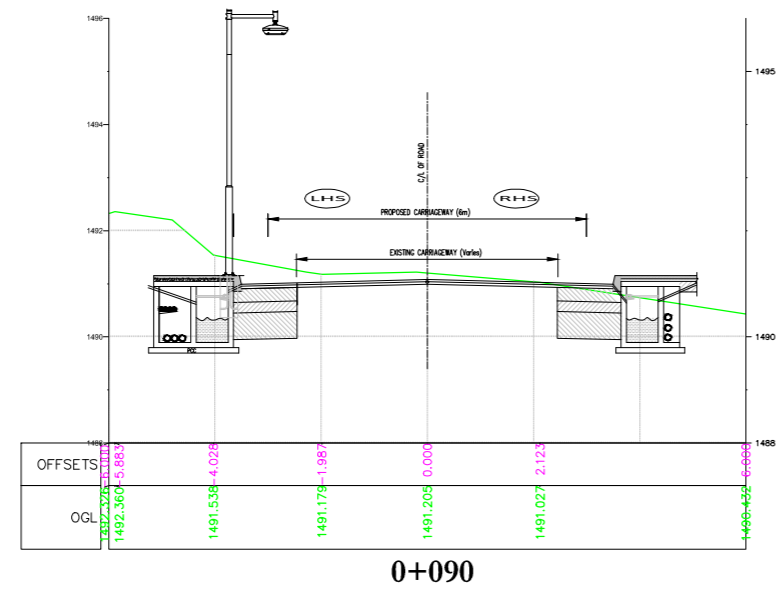
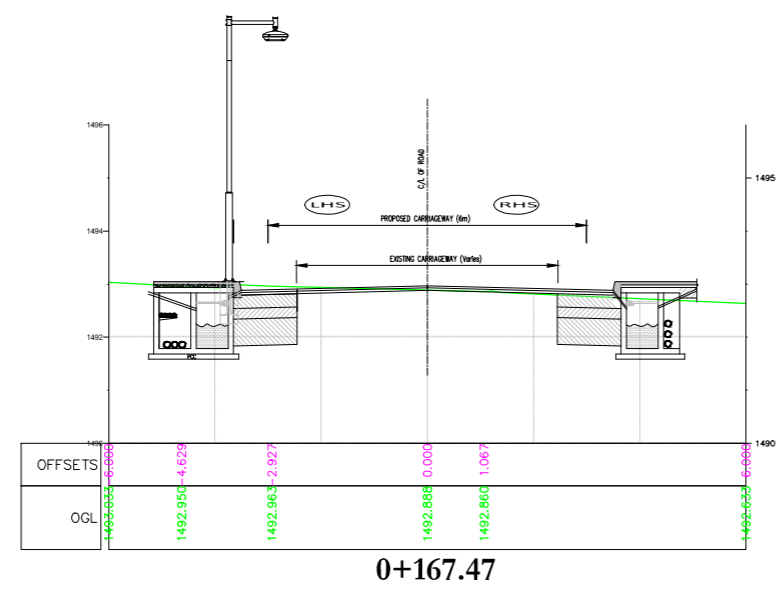

DRAWINGS ARE FOR TENDER PURPOSES ONLY

Rev	dd/mm/yyyy	Description	Rev by	dd/mm/yyyy

Designed :	IPEG
Checked :	
Approved :	

Client

**SHILLONG
SMART CITY LIMITED**

Submitted By

IPE GLOBAL
Expanding Horizons. Enriching Lives.

Project:

DEVELOPMENT OF SMART ROAD IN SHILLONG

Dr Title:

**(RD-08A)
CROSS SECTIONS
(From STA : 0+000 to STA : 0+167.47)**

Dr No :	RD-8A/CS-08A
Scale :	NTS
Date :	10.02.2020
Contract No. :	
Rev	RO